

TGrade Dry Bath Incubator User's Manual



Cat. No.	Product Name	temp Control Range
OSE-DB-01	Heating Type TGrade Dry Bath Incubator	Room temp+5°C-105°C
OSE-DB-02	Cooling Type TGrade Dry Bath Incubator	Room temp-25°C-105°C

Product Description

OSE-DB-01 heating type TGrade Dry Bath Incubator is a dry constant temperature metal bath. When 24V DC is connected, the temperature can be maintained at the specified value from room temperature to 105°C. Five time and temperature periods can be set. The bath is operated in five time periods in turn, and maintained at room temperature after the end of the program. OSE-DB-02 cooling type TGrade Dry Bath Incubator can maintain temperature within -10°C~100°C (to reach -10°C, the environment temperature needs to be at 15°C or below). The bath is operated in five time periods in turn, and maintained at room temperature after the end of the program. OSE-DB-01/OSE-DB-02 can hold a 96-well PCR plate aluminum blocks with optional aperture models to match different tubes: 0.2 ml, 0.5 ml, 1.5 ml, 2 ml, 15 ml, 50 ml. Contact us for other standard or special type of working aluminum block.

Package Contents

TGrade Dry Bath Incubator	1 set
T-Handle	1
Thermal Insulation Cover	1
Power Cord, Power Adapter	1
User's Manual	1 copy
Warranty Card	1 copy

Instrument Diagram

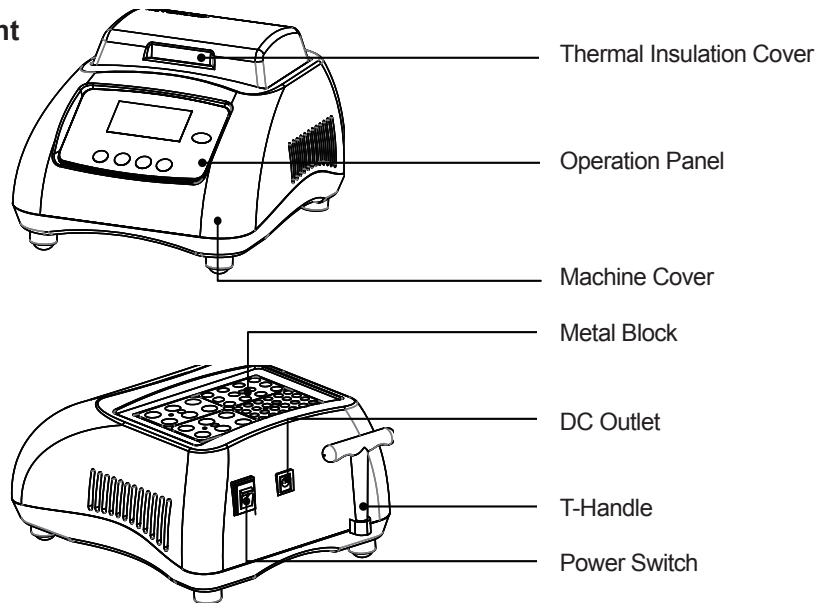

Appendix: Wiring diagram of OSE-DB-01/OSE-DB-02 TGrade Dry Bath Incubator

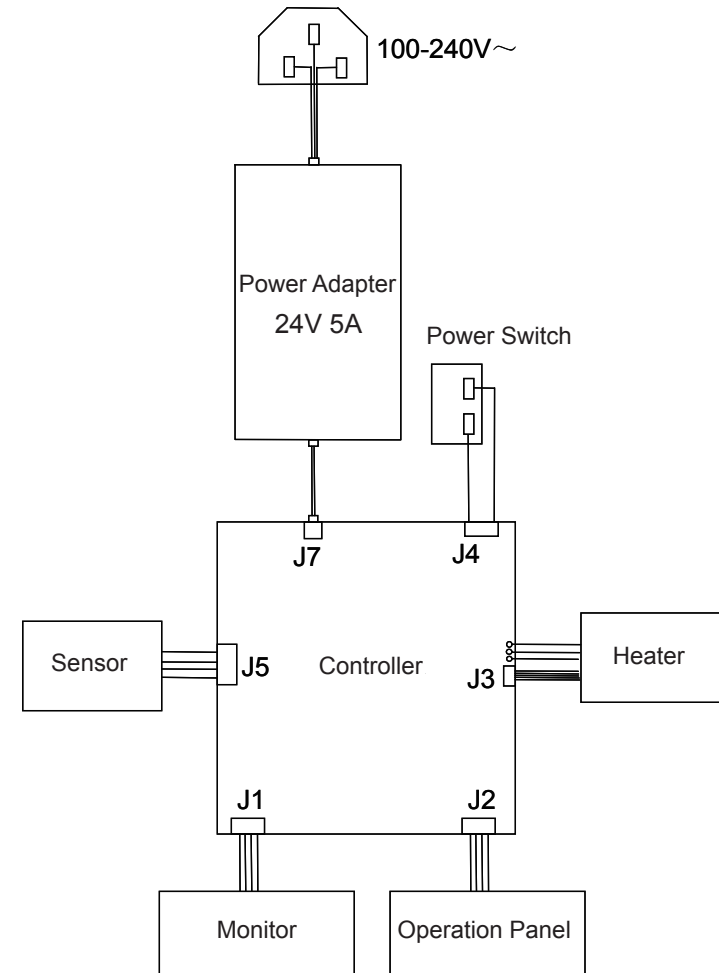







Parameters

Cat. No.	OSE-DB-01	OSE-DB-02
The Temperature Setting Range	5°C-105°C	-10°C-105°C
The Temperature Control Range	Room temp +5°C-105°C	Room temp -25°C-105°C
Heating Time	≤15min (from room temp* to 105°C)	
Cooling Time	≤30 min (from 105°C to room temp*)	≤15 min (from 105°C to room temp*)
Accuracy of the temperature at 105°C	≤±0.5°C	
Maximum Temperature Difference of 40°C Module	0.3°C	
Timing Range	1-99h59min	
Input Power	24V, 5A	
Weight	1.1 kg	1.9 kg

* The room temperature here is 25°C



Safety Warning

-  This instrument is a product for indoor use.
-  Please read this operation manual carefully before operating this instrument to avoid personal injury. Professional operation only.
-  For no-TIANGEN operators, do not attempt to dismantle or repair the instrument, so as to avoid losing the qualification of instrument warranty or suffering from electric shock. For maintenance, contact TIANGEN or its dealer's service personnel.
-  Please place the instrument in a cool and dry environment with less dust, keep away from water and avoid direct sunlight. Keep the inner part of the device ventilated and dry to avoid the interference of corrosive gas, liquid or instruments with magnetic field.
-   The power switch is on the right rear side of the instrument. Press "I" to turn on the power. Press "O", to turn off the power. Please turn on the power adapter before turning on the power to "I".

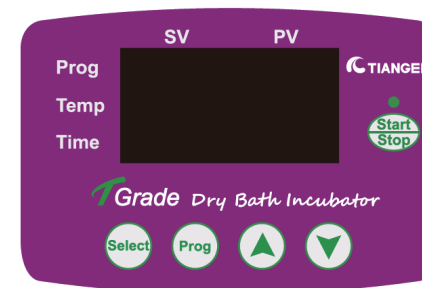
Operation Panel



Instruction of the Operation Keys

-  The key to increase setting time, temperature or change programs.
-  The key to decrease setting time, temperature or change programs.
- Select The cursor switch key. For switching of time, temperature and program .
- Prog Program switch key. Press to enter the next program set. Can be switch in cycle.
- Start/Stop Run and stop key: When the temperature time setting is completed, press this key to start the operation. During operation, press this key for 2 seconds to stop the operation.

Instrument Installation

- Place the metal bath on a horizontal workbench.
- Connect the other end of the power line with the power supply. The power supply voltage shall be 220/110V.
- Turn on the power switch on the right rear side of the instrument, and the instrument will enter the setting state.

User Guide

- Turn on the power switch and the screen shows "TIANGEN"; The instrument then enters initialization, accompanied by the sound of "Beep". After about 3 seconds, the instrument enters the operation interface.

As shown in Figure 1, the value "S1-S5" in the display window indicates that the program runs continuously from S1 to S5, and "37.0" on the left indicates the set target temperature;



Figure 1

"00:30" indicates that the set time is 30 minutes. "S2" on the right indicates that the current running program is S2, "27.7" indicates the temperature of the current module, and "00:00" indicates the remaining time of the countdown. Since the current temperature has not reached the set temperature, the countdown has not yet started.

- When the "Select" key is pressed, the last digit of the first column starts to flash. Continue to press the "Select" key to adjust the cursor position, and press the "▲" key to adjust the value of the cursor position. Press "Prog" key once to switch from S1 to S5 as shown in Figure 1 on the right.
- A constant temperature program can be made by setting "S1-S1". Nothing will change when press "Prog" key at this condition.
- When the time is set to "00:00", it means the time operation value is zero, and this step will be skipped during the operation. When the time is set to "--:--", it means the time operation value is ∞, and the instrument will remain at a constant temperature as the set temperature.



Figure 2

- Example: Set the parameters in Figure 2 as those shown in Figure 3.
 - Press the "Select" key to adjust the cursor to "S5", and then press the "▲" key to change "5" to "3";
 - Press "Select" to switch the cursor to "37.0", and then press "▲" key to modify the temperature of this experiment to "90.0". Long press "▲" key to increase the number in single digits of temperature parameter.
To make fine adjustment, press the "▲" key once to increase 0.1°C.
 - The setting method of time parameter is the same as above.
 - When the program is completed, the temperature will be balanced to room temperature.

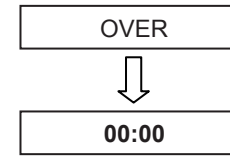

Figure 3

Running and Terminating the Programs

- Press the "Start/Stop" key to start the instrument after setting. When the temperature reaches the set temperature, the countdown starts.
- When the temperature increases, the indicator light on the "Start/Stop" key flashes. When the temperature increases to the target temperature, it enters the constant state, and the indicator light is long on.

- When the timing reaches zero, the instrument will "beep" for five alarms, and the countdown on the screen will display "OVER".



Press any key to return to the program interface, and the instrument can be set and re-run again.

- Press and hold the "Start/Stop" key for 2 seconds, the program is terminated, and the timing ends.

Maintenance and Service



The deep holes on the block should be regularly cleaned with a clean soft cloth dipped with a small amount of absolute ethanol to ensure that the tubes and the cone hole wall contact fully with good thermal conductivity, and avoid pollution.

If there is any stain on the surface of the instrument, it can be cleaned with soft cloth and cleaning paste.



Before cleaning the instrument, the power of the instrument must be turned off. Do not pour the cleaning solution into the hole of the block during cleaning. Do not use corrosive cleaning agents to clean blocks and the instrument.

Fault Analysis and Handling

Fault Conditions	Possible Causes	Suggestions
OLED doesn't light up	Power is off	Check the power supply and unplug it again
	Switch is broken	Change the switch
	Controller damaged	Contact TIANGEN after-sales or your local distributor
The temperature displays "Error" with a warning voice "Beep"	The sensor at the block area has a short circuit	Contact TIANGEN after-sales or your local distributor
The display temperature is far from the actual temperature	Damaged sensor or poor block contact	Contact TIANGEN after-sales or your local distributor
The block doesn't heat up	Temperature sensor damaged	Contact TIANGEN after-sales or your local distributor
	Solid state relay damaged	
	Heating pipe damaged	
The keys are not working	Key damaged	Contact TIANGEN after-sales or your local distributor